

## Product Group Chart

### Organic Conductive Polymer Capacitors (OP-CAP)

#### SMD Type

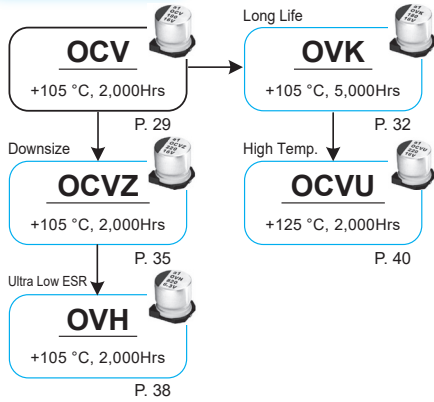

#### Radial Type

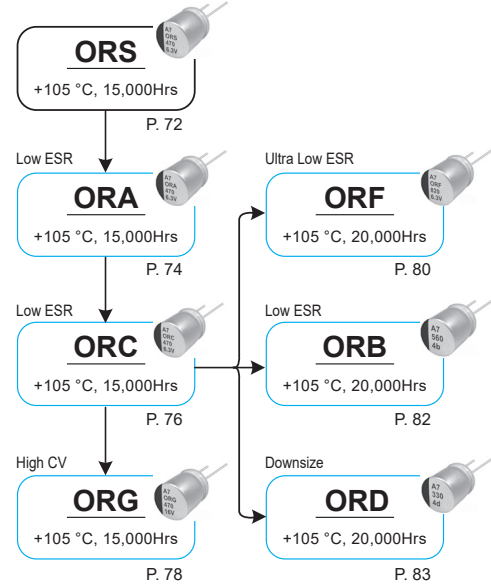
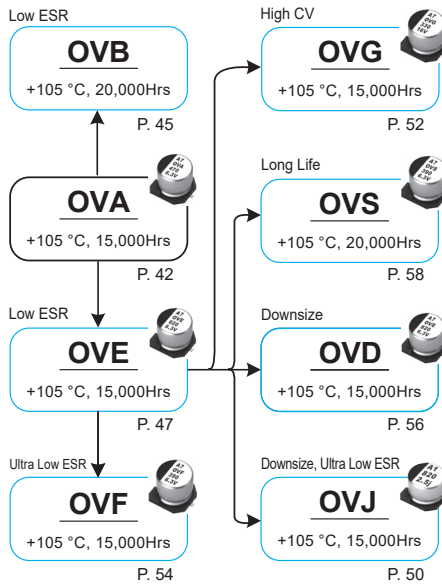
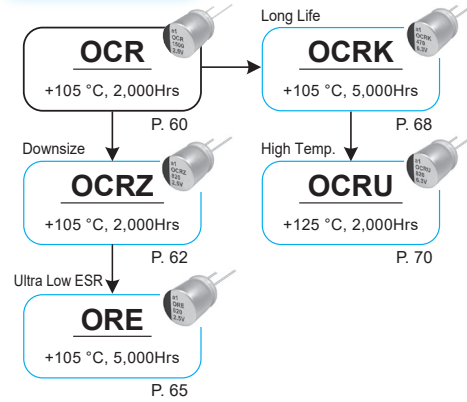

### Conductive Polymer Hybrid Capacitors

#### SMD Type

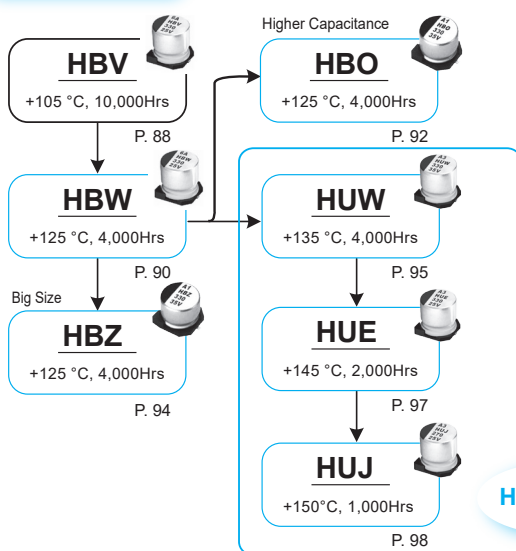

#### Radial Type

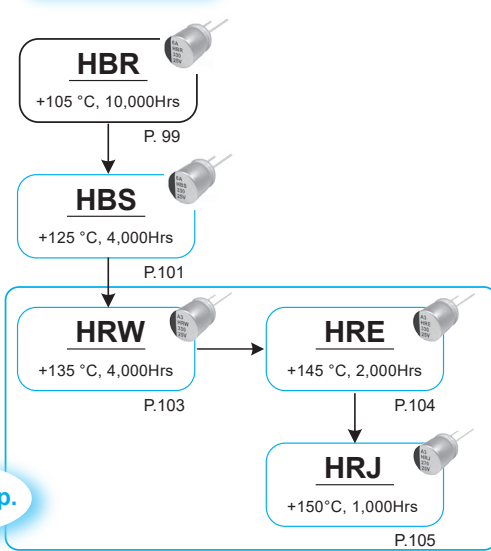

High Temp.

Note: Special application available upon request.

## SMD Aluminum Electrolytic Capacitors

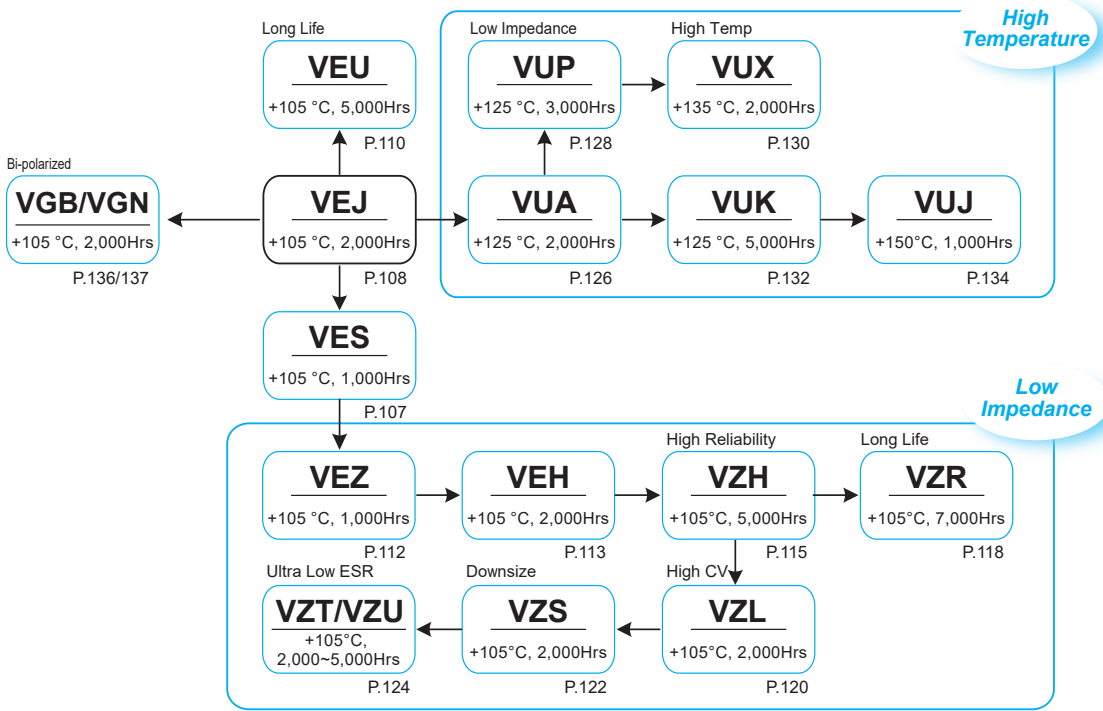

## Radial Type

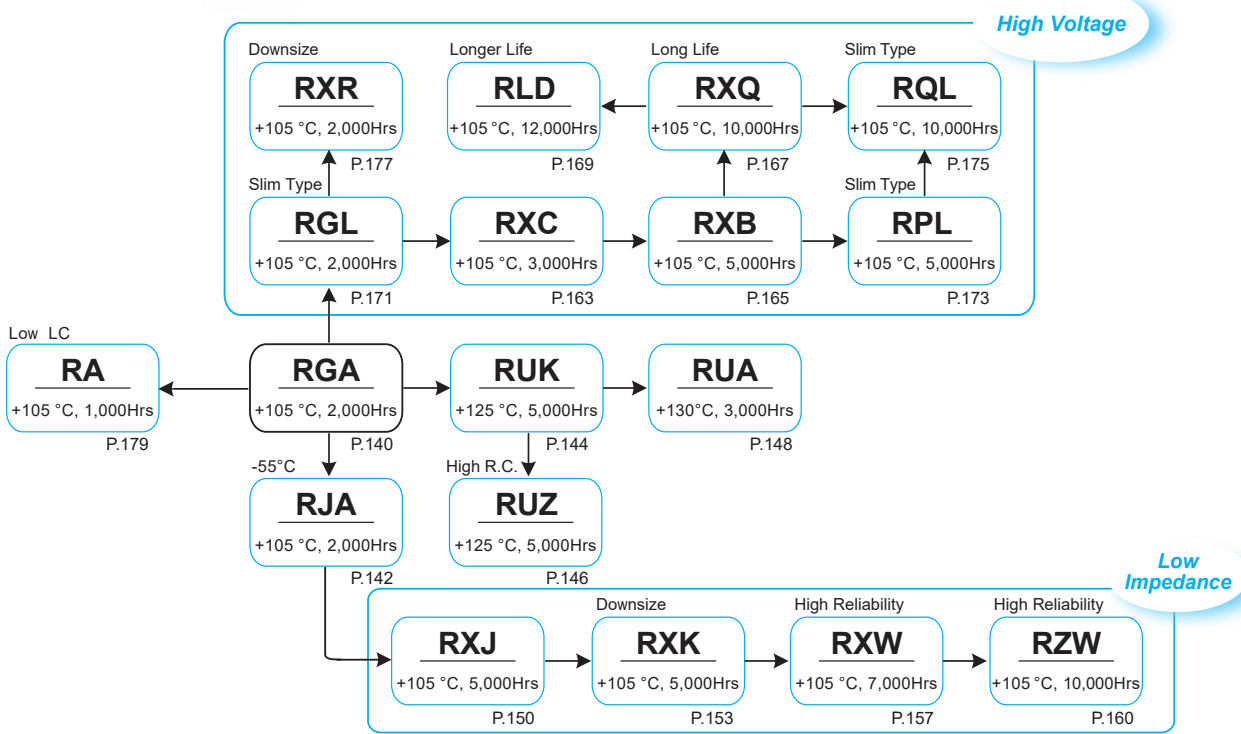

## Flame Retardant

Snap-in Type

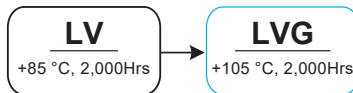

Radial Type



Note: Special application available upon request.

## ● Radial - 7mmL and 5mmL

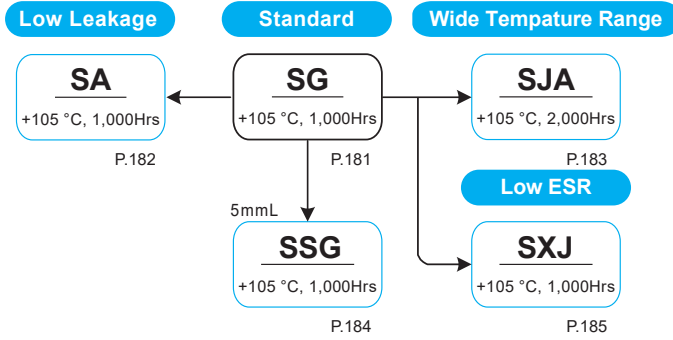

## ● Bi-polarized

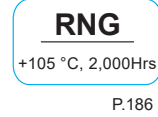

## ● Snap-in Terminal

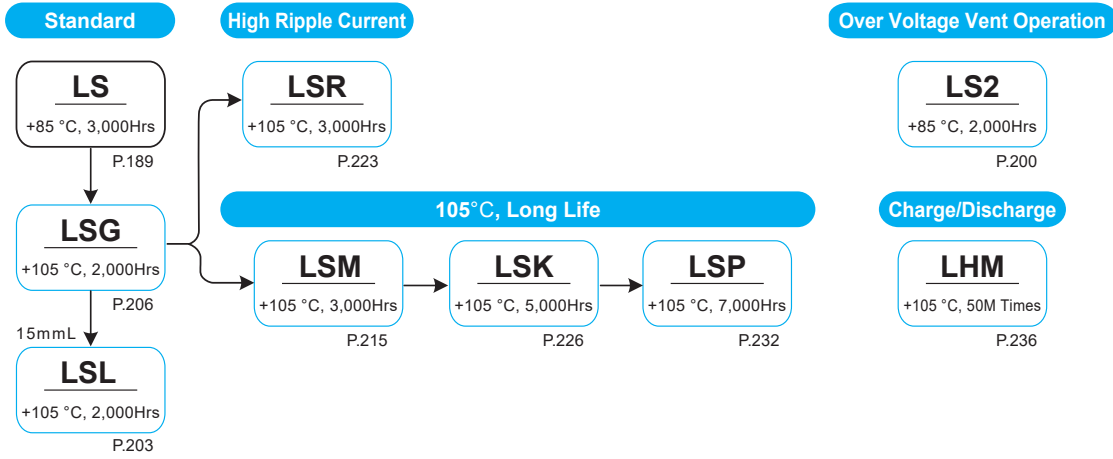

## ● Screw Terminal

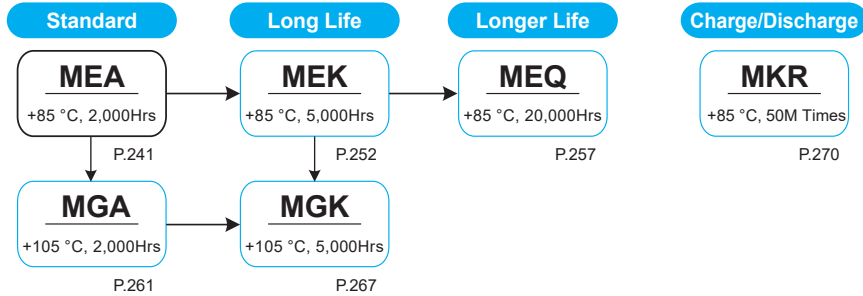

Note: Special application available upon request.

## ● Axial (not included in this catalog)

### Axial-lead

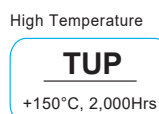
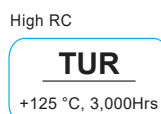

### Soldering Star

